

**FICHE D'HOMOLOGATION
HOMOLOGATION FORM**

Homologation N°

181/FR/14



**COMMISSION INTERNATIONALE
DE KARTING - FIA**



SYSTÈME DE FREINAGE / BRAKING SYSTEM



Constructeur	<i>Manufacturer</i>	Parolin Racing Kart s.r.l.
Marque	<i>Make</i>	Eurostar
Modèle	<i>Model</i>	AP Race 01
Catégorie	<i>Category</i>	Sans boîte de vitesses/ <i>Non-gearbox</i>
Durée de l'homologation	<i>Validity of the homologation</i>	6 ans / <i>years</i>
Nombre de pages	<i>Number of pages</i>	4

La présente Fiche d'Homologation reproduit descriptions, illustrations et dimensions du système de freinage au moment de l'homologation CIK-FIA. Le Constructeur a la possibilité de les modifier, mais seulement dans les limites fixées par le Règlement CIK-FIA en vigueur.

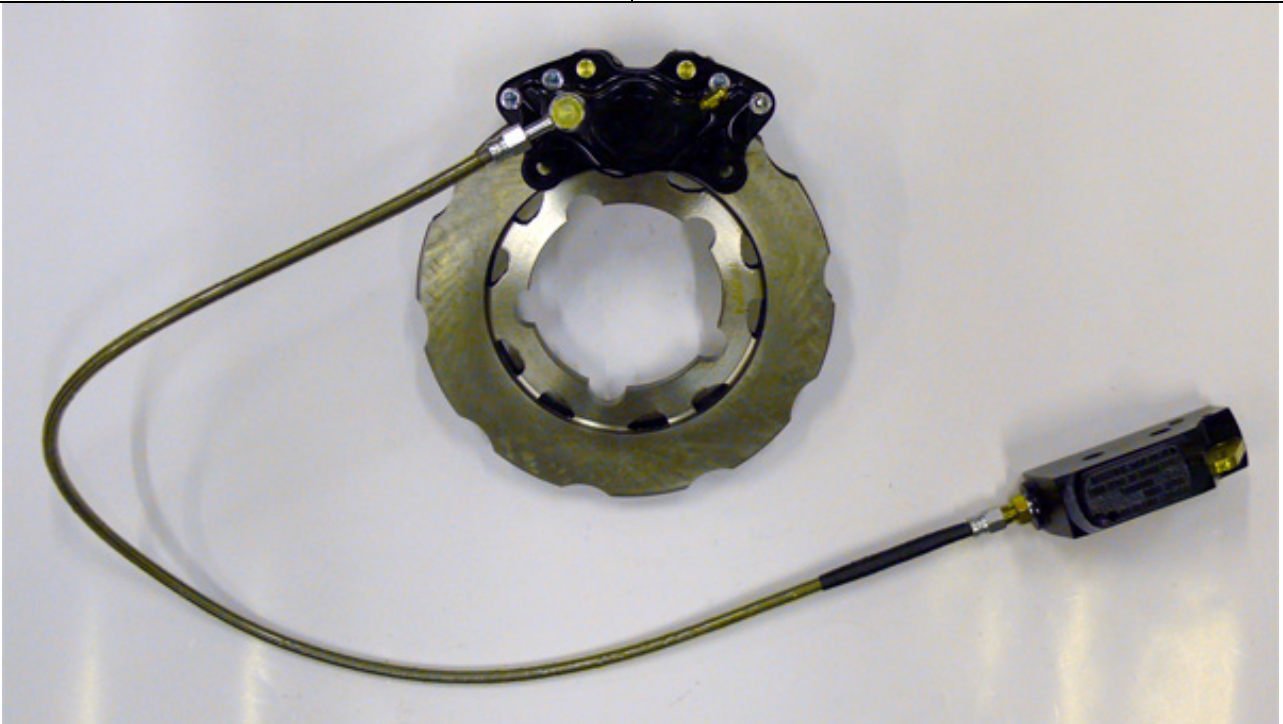
This Homologation Form reproduces descriptions, illustrations and dimensions of the brake system at the moment of the CIK-FIA homologation. The Manufacturer may modify them, but only within the limits set by the CIK-FIA Regulations in force.

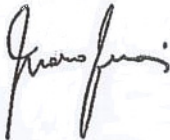

**PHOTO VUE DE DESSUS DU SYSTÈME COMPLET ASSEMBLÉ
PHOTO FROM ABOVE OF COMPLETE ASSEMBLED SYSTEM**

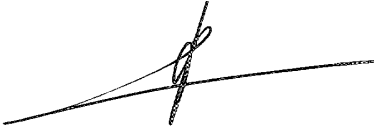
Signature et tampon de l'ASN <i>Signature and stamp of the ASN</i>	Signature et tampon de la CIK-FIA <i>Signature and stamp of the CIK-FIA</i>
 	 

A	DESSIN TECHNIQUE DU SYTÈME DE FREINAGE Dessin technique éclaté	A	<i>TECHNICAL DRAWING OF BRAKING SYSTEM Exploded technical drawing</i>
----------	---	----------	---

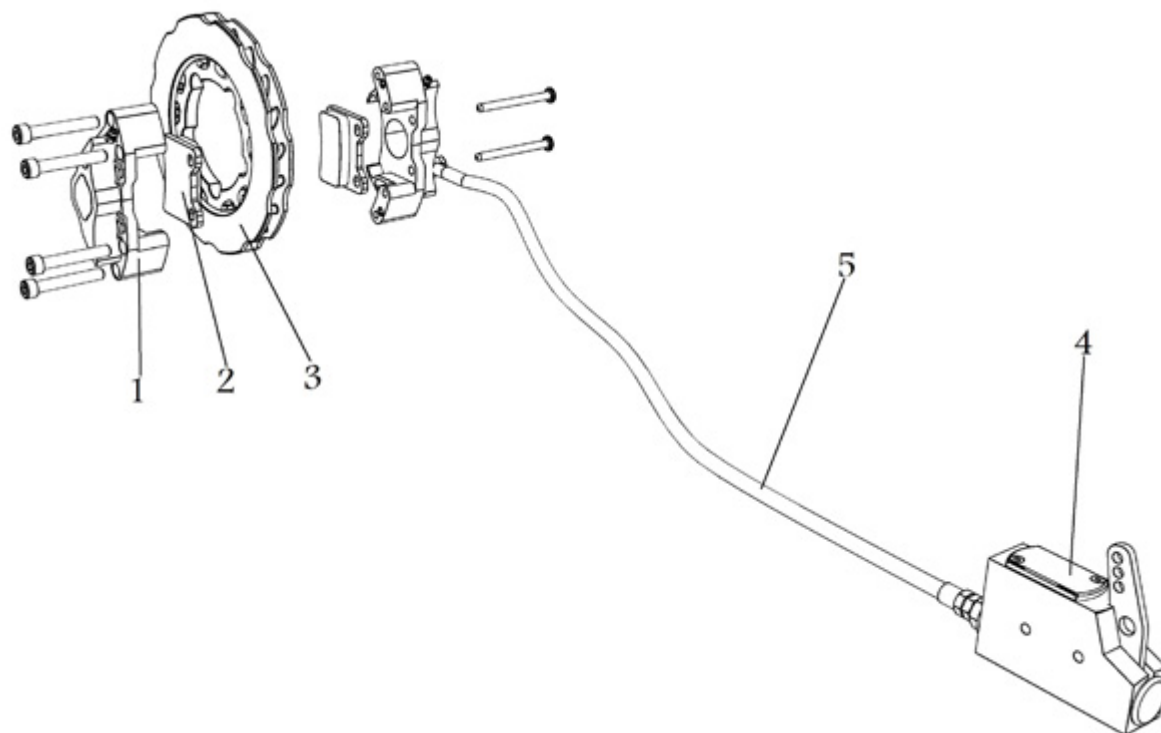

Le dessin technique doit montrer : Maître-cylindre, régulateur, tuyaux, étriers, plaquettes et disques (numérotation selon table ci-dessous)

The technical drawing must show the following: Master-cylinder, regulator, lines, calipers, pads and discs (with numbering according table below)

N°	DÉSIGNATION (en français)	DESIGNATION (in english)	Référence catalogue Catalogue reference number
1	Pince de frein arriere	Rear brake caliper	fr001
2	Plaquettes de frein arriere	Rear brake pads	fr003
3	Disque frein arriere	Rear brake disc	fr005
4	Pompe de frein	Brake pumps	fr007
5	Tuyaux arriere	Rear brake line	fr008
6			
7			
8			
9			
10			

B	DESCRIPTION TECHNIQUE DU SYSTÈME DE FREINAGE	B	TECHNICAL DESCRIPTION OF BRAKING SYSTEM	
	Régulateur de freinage <i>Braking regulator</i>	<input type="checkbox"/> oui / yes <input checked="" type="checkbox"/> non / no	Emplacement <i>Location</i>	_____
	Avant / Front		Arrière / Rear	
	Nombre de maîtres-cylindres <i>Number of master cylinders</i>	_____	1	
	Alésage Ø <i>Bore Ø</i>	_____ mm	22 mm	
	Nombre de pistons <i>Number of pistons</i>	_____	2	Par étrier <i>Per caliper</i>
	Alésage Ø de l'étrier <i>Caliper bore Ø</i>	_____ mm	31.6 mm	
	Nombre de plaquettes <i>Number of pads</i>	_____	2	Par étrier <i>Per caliper</i>
	Nombre d'étriers <i>Number of calipers</i>	_____	1	
	Matériau des étriers <i>Caliper material</i>	_____	Alu	
	Disques ventilés <i>Ventilated discs</i>	<input type="checkbox"/> oui / yes <input type="checkbox"/> non / no	<input checked="" type="checkbox"/> oui / yes <input type="checkbox"/> non / no	
	Épaisseur du disque neuf <i>Thickness of new disc</i>	_____ mm	+/- 1 mm	18 mm +/- 1 mm
	Ø extérieur du disque <i>External Ø of the disc</i>	_____ mm	+/- 1.5 mm	194 mm +/- 1.5 mm
	Ø extérieur de frottement des plaquettes <i>External Ø of pads rubbing surface</i>	_____ mm	+/- 1.5 mm	194 mm +/- 1.5 mm
	Ø intérieur de frottement des plaquettes <i>Internal Ø of pads rubbing surface</i>	_____ mm	+/- 1.5 mm	131 mm +/- 1.5 mm
	Longueur hors-tout des plaquettes <i>Overall length of the pads</i>	_____ mm	+/- 1.5 mm	62 mm +/- 1.5 mm

Photo du frein avant : étriers et disques seulement <i>Photo of front brake: calipers and discs only</i>	Photo du frein arrière : étrier(s) et disque(s) seulement <i>Photo of rear brake: caliper(s) and disc(s) only</i>
	

PHOTO DU MARQUAGE DU NUMERO D'HOMOLOGATION
 PHOTO OF THE HOMOLOGATION NUMBER MARKING

Le marquage doit rester clairement visible en permanence
The marking must be clearly visible at all times

Maître-cylindre / Master-cylinder

Tuyaux / Lines

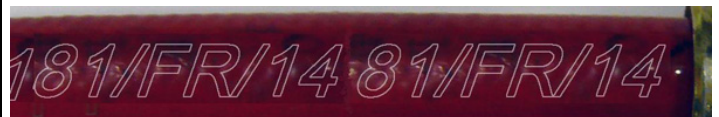

Etriers / Calipers

Plaquettes / Pads



Disques / Discs

Régulateur / Regulator

