



BRP-ROTAX CHASSIS APPROVAL FORM



Manufacturer	VANSPEED
Chassis model	SATURNO
Category	ROTAX MAX Challenge, 125 MAX DD2 class
Validity of approval	without limitation
Date of approval by BRP-ROTAX	2007 07 20

Technical definiton of the frame
Built according to CIK regualtions for short circuits karts

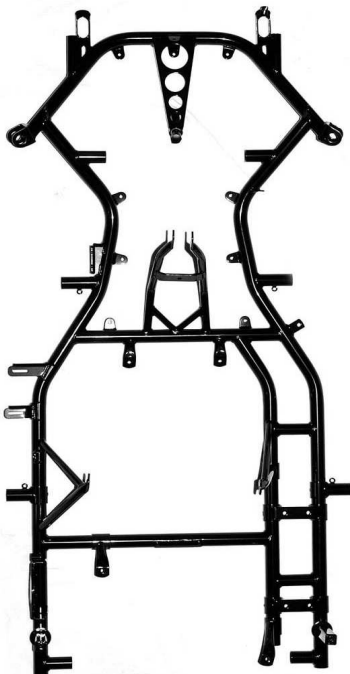
Technical definition of the components of the chassis	
Brake system:	Designed according to CIK rules for shifter classes. A brake system with a valid CIK Homologation must be used.
Bodywork:	Designed according to CIK rules for short circuit karts. A bodywork with a valid CIK Homologation must be used.
Rear Tire Protection System:	For the participation at national or internatioinal ROTAX MAX Challenge race, the ROTAX Rear Tire Protection System must be used.

	
Foto from above of the frame (without any monted part)	Foto of the identification plate of the frame with the name of the chassis model.

Technical description	Dimensions	Tolerance
Outer diameter of the main tubes (without painting)	mm 32	+/- 0,5 mm
Rear width of main tubes (center line to center line)	mm 650	+/- 5,0 mm
Distance of the rear two main tubes on the right side (center line to center line)	mm 104	+/- 0,5 mm
Wheelbase	mm 1050	+/- 5,0 mm

Technical description	Figure
Number of adjustable/removeable stabilizers at the frame	2

BRP-ROTAX CHASSIS APPROVAL FORM



Foto from above of the frame with the section of the engine mount



Foto from above of the frame with the section of the two supports for the exhaust system

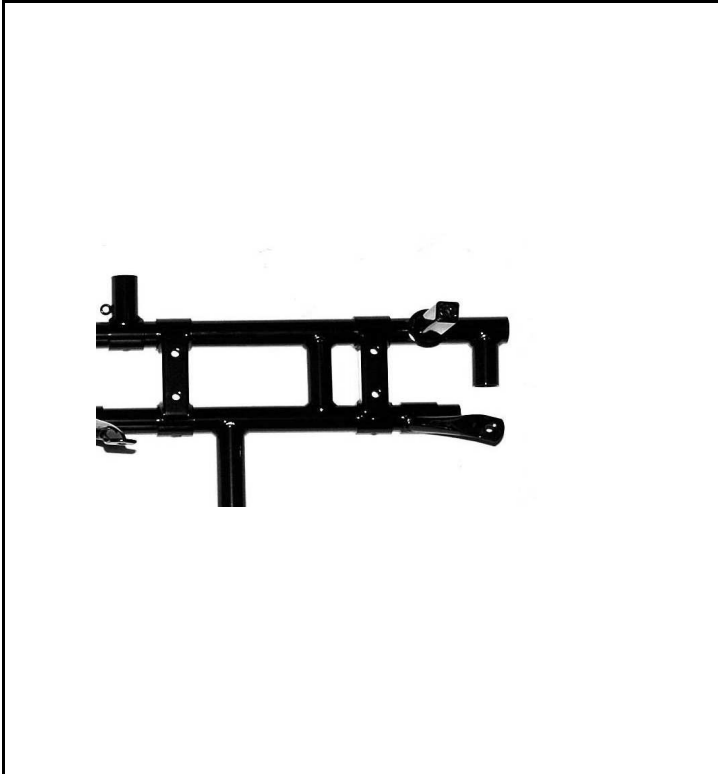

Foto of the frame with the section of the support for the fuel pump (fuel pump mounted)

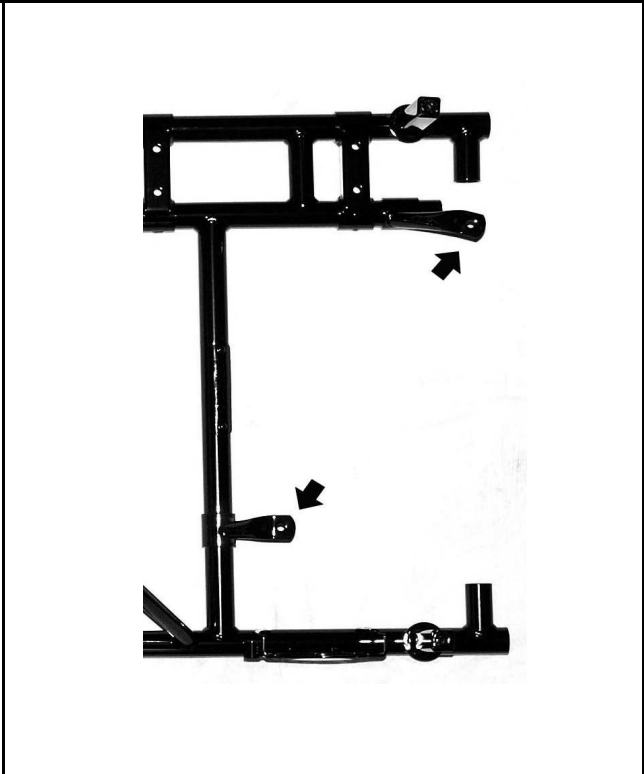

Foto of the frame from the side with the section of the supports for the radiator (radiator mounted)

BRP-ROTAX CHASSIS APPROVAL FORM

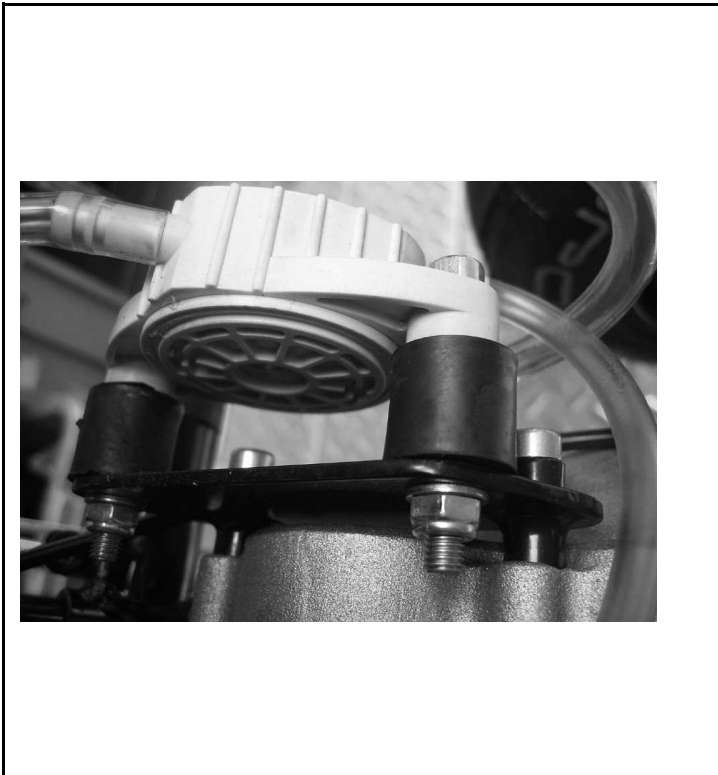

Foto from the steering column with the section with the knurling for the steering wheel hub (knurling according to DIN 82 - RAA1).

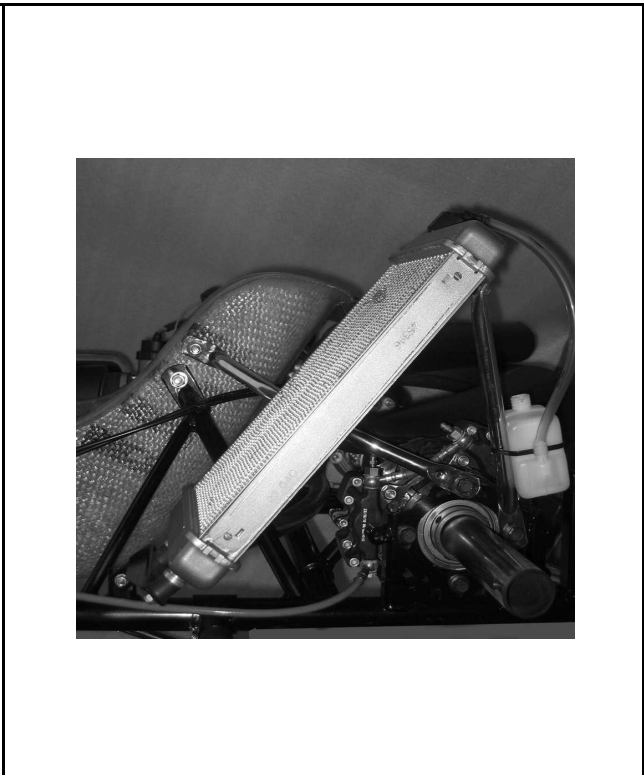

Foto from above of the frame with the section of the two supports for the RTPS (Rear Tire Protection System)



Foto of the frame from the side with the section of the support for the RTPS (Rear Tire Protection System)

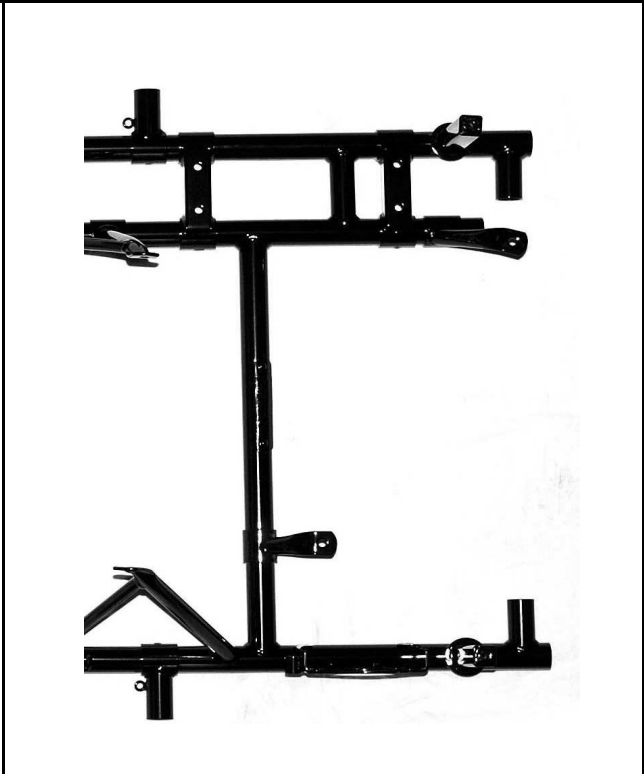
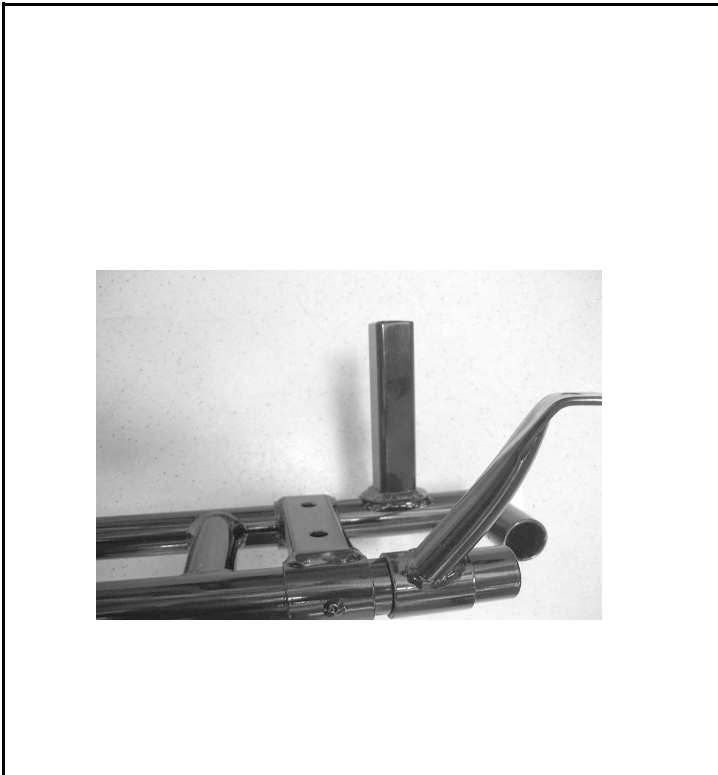

Foto of the frame from the back with the section of the support for the RTPS (Rear Tire Protection System)