

FICHE D'HOMOLOGATION HOMOLOGATION FORM



COMMISSION INTERNATIONALE DE KARTING - FIA



CADRE DU CHÂSSIS / CHASSIS FRAME

Constructeur	<i>Manufacturer</i>	BEST KART Snc
Marque	<i>Make</i>	Best Kart
Modèle	<i>Model</i>	DIABLO / F 02
Catégorie	<i>Category</i>	All categories
Durée de l'homologation	<i>Validity of the homologation</i>	6 ans / years
Nombre de pages	<i>Number of pages</i>	4

La présente Fiche d'Homologation reproduit descriptions, illustrations et dimensions du cadre du châssis au moment de l'homologation CIK-FIA. Le Constructeur a la possibilité de les modifier par extension, mais seulement dans les limites fixées par le Règlement CIK-FIA en vigueur.

This Homologation Form reproduces descriptions, illustrations and dimensions of the chassis frame at the moment of the CIK-FIA homologation. The Manufacturer may modify them by Extension, but only within the limits set by the CIK-FIA Regulations in force.

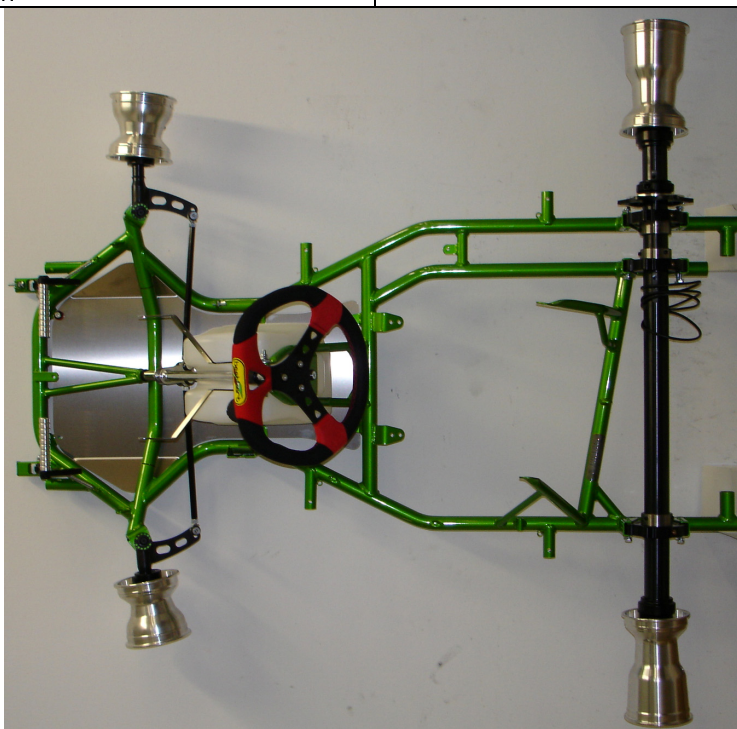

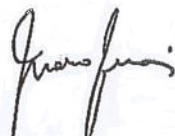

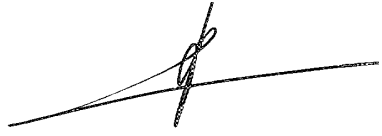

PHOTO VUE DE DESSUS DU CHÂSSIS COMPLET IDENTIQUE À L'UN DES MODÈLES PRÉSENTÉS À L'HOMOLOGATION SANS PARE-CHOCS, CARROSSERIE, SIEGE, NI PNEUMATIQUES

PHOTO FROM ABOVE OF COMPLETE CHASSIS IDENTICAL TO ONE OF THE MODELS SUBMITTED FOR HOMOLOGATION WITHOUT BUMPERS, BODYWORK, SEAT OR TYRES

Signature et tampon de l'ASN <i>Signature and stamp of the ASN</i>	Signature et tampon de la CIK-FIA <i>Signature and stamp of the CIK-FIA</i>
 	 

A DESSIN TECHNIQUE DU CADRE - Échelle 1:10

A TECHNICAL DRAWING OF FRAME – Scale 1:10

Le dessin technique sert pour identifier la structure et la géométrie principale du cadre. (dimensions et numérotation des tubes selon tableau section B)
 The technical drawing is used for the identification of the structure and the main geometry of the frame. (dimensions and tubes numbering according table in section B)

VUE DE DESSUS / VIEW FROM ABOVE

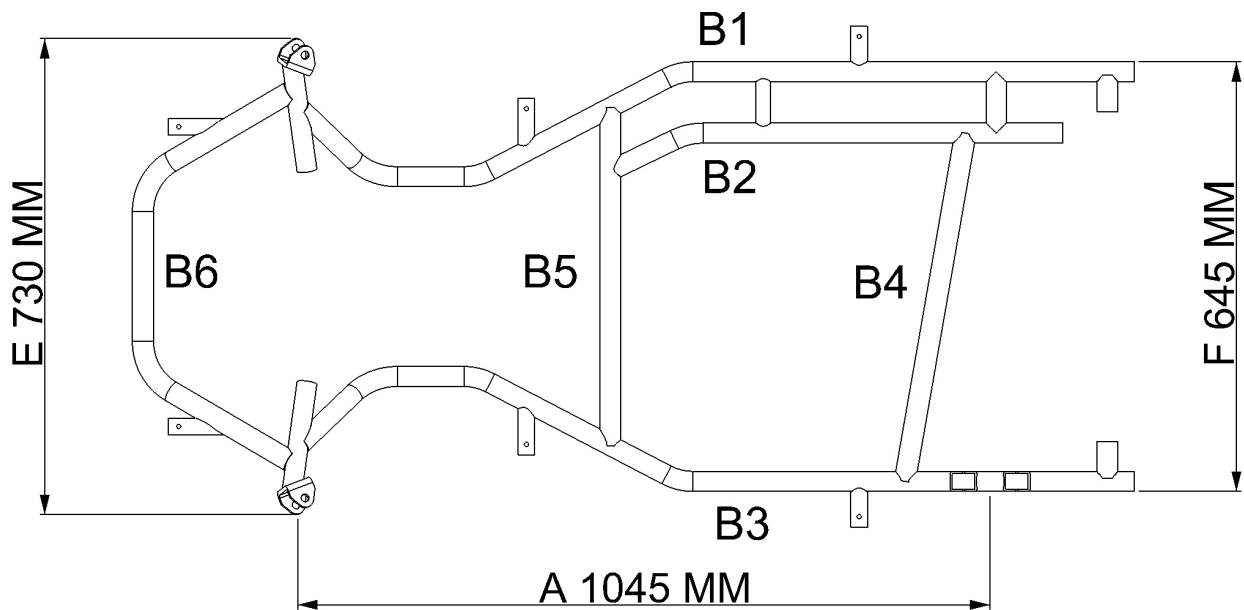

Représenter seulement les tubes principaux de la structure et les attaches supportant les fusées et les barres de rigidification nécessitant informations et dimensions à la section B
 Only show tubes from the structure and fixations sustaining the stub axles and the stiffening bars that require details and dimensions as featured in section B

VUE DE CÔTÉ / SIDE VIEW



B	COTES	B	DIMENSIONS
1. Cadre	1. Frame	Données	Tolérances
		Data	Tolerances
A= Empattement mesures fixes	A= Wheel base fixed measurements	1045	+/- 10mm
B= Tubes principaux de la structure, diamètre minimum 21mm, d'une longueur supérieure à 150mm, à l'exception des tubes d'un diamètre inférieur à 21mm et tous les supports pour les accessoires.	B= Main tubes of the structure, minimum diameter of 21mm, length over 150mm, except tubes with a diameter of less than 21mm and all the supports for the accessories.	1) 30 2) 30 3) 30 4) 32 5) 32 6) 32 7) 8) 9) 10)	+/- 0.5mm +/- 0.5mm +/- 0.5mm +/- 0.5mm +/- 0.5mm +/- 0.5mm +/- 0.5mm +/- 0.5mm +/- 0.5mm +/- 0.5mm
C = Nombre de courbes dans les tubes de Ø supérieur à 21mm	C = Number of bends on the tubes with a diameter greater than 21mm.	9	—
D = Nombre de tubes ayant un Ø supérieur à 21mm	D = Number of tubes with a diameter greater than 21mm	6	—
E = Largeur avant extérieure	E = Outer front width	730	+/- 10mm
F = Largeur arrière extérieure	F = Outer rear width	645	+/- 10mm
G1 = Porte-à-faux arrière des tubes principaux (obligatoire)	G1 = Rear overhang for the main tubes (mandatory)	210	+/- 15mm
G2 = Porte-à-faux avant du tube principal	G2 = Front overhang for the main tube	252	+/- 10mm
<i>Remarque / Remark:</i> Dans les points B, C et D, seuls les tubes principaux d'une longueur supérieure à 150 mm sont à prendre en considération à l'exclusion tous les supports pour accessoires. <i>In points B, C and D, only the main tubes of a length of more than 150 mm are to be taken into consideration, excluding all supports for accessories.</i>			

C	PHOTO DU MARQUAGE DU NUMERO D'HOMOLOGATION	C	PHOTO OF THE HOMOLOGATION NUMBER MARKING
			
<p>Le marquage indiqué sur le tube transversal arrière doit rester clairement visible en permanence The marking located on the rear strut must be clearly visible at all times</p>			

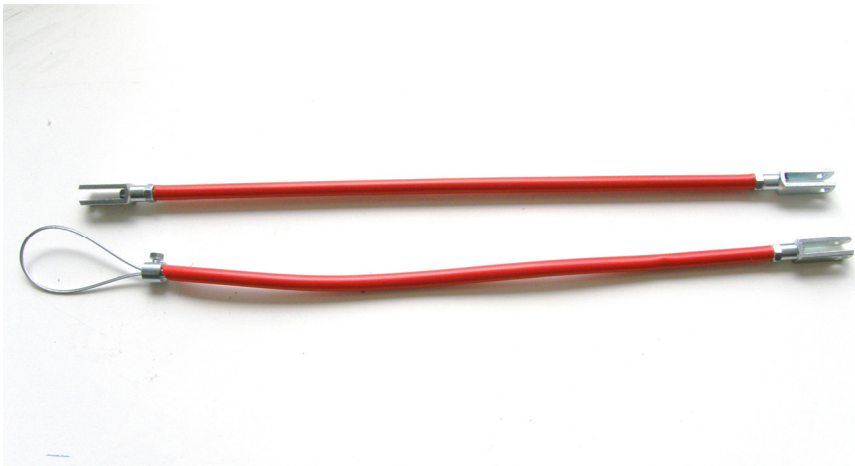
d	PHOTO DE LA COMMANDE DE FREINAGE	d	PHOTO OF BRAKE CONTROL CABLE
<div data-bbox="355 434 1214 898" data-label="Image">A photograph showing two red brake control cables. The top cable is straight with metal fittings at both ends. The bottom cable has a metal loop at one end and a metal fitting at the other. Both cables are laid out horizontally on a white background.</div> <p data-bbox="245 958 1340 1019">La commande de freinage doit être isolée du châssis et montrer la double commande <i>The brake control must be separated from chassis and show the double linkage</i></p>			